

WWW.RONDADDESIGN.IT

N O W

M O N

Poltrona Zanussi • T.P. Motta-Foggo Assocati • Gioi Romolano • Loro-Muturo • Light Lighting •
Mestre Dato • Cingotti Assocati • Piana • Romolano • Compagnie d'Arte • Experimentaldesign • Plus a Milano •



NEVER STOP CREATING



APP DESIGN S.r.l.
Via Volta, 29 - 36010 Zané (VI) - Tel. +39 0445 1850142 - Fax +39 0445 1850143
sales@rondadesign.it - www.rondadesign.it





NEVER STOP CREATING

Con il catalogo **NOW**, **Ronda Design** presenta la nuova collezione living 2017. Ogni prodotto, realizzato sfruttando la profonda esperienza dell'azienda nella lavorazione dei metalli, si caratterizza per l'originalità di forme, materiali e funzioni.

Ronda Design è una realtà in continua evoluzione, sempre in grado di sorprendere con soluzioni insolite e tecnologie innovative.

The **NOW** catalogue showcases **Ronda Design's** new Living room collection products for 2017.

Every product is created exploiting the company's profound experience in metal processing and stands out for its original shapes, materials and functionality. The ever-progressive **Ronda Design** is always in a position to amaze with its unusual solutions and innovative technologies.

WWW.RONDADESIGN.IT

R O N D A

D E S I G N

L A B



QUASIMODO Design: Adriani e Rossi
Tavolo con base in metallo finitura grafite e ripiano irregolare in finitura cemento spatolato.
Table with graphite varnished metal base and an irregularly shaped top in brushed concrete finishing.
L. 2200 P. 1200 H. 760 mm

2

IZOARD Design: Adriani e Rossi
Sedia con struttura in metallo finitura grafite e seduta rivestita in pelle nocciola.
Chair with graphite varnished metal structure and seat covered in walnut leather.
L. 560 P. 572 H. 780 mm

3



QUASIMODO Design: Adriani e Rossi

Tavolo con base in metallo finitura griffite e ripiano irregolare in finitura cemento spatolato.

Table with graphite varnished metal base and an irregularly shaped top in brushed concrete finishing.

L. 2200 P. 1200 H. 760 mm



QUASIMODO Design: Adriani e Rossi
Tavolo con base in metallo e ripiano dalla forma irregolare in vetro nero.
Table with metal base and an irregularly shaped top in black glass.
L. 2200 P. 1200 H. 760 mm



IZOARD Design: Adriani e Rossi
Sedia con struttura in metallo lustrato e seduta rivestita in pelle nocciola.
Chair with graphite varnished metal structure and seat covered in walnut leather.
L. 560 P. 572 H. 780 mm



GIORNO - LIVING

I R O N R 1 0

L 3960 P 560 H 2160 mm

Composizione giorno in metallo finitura
grafite con ante in finitura cemento.
Libreria modulare **IRON-IC** integrata.
Mensole e porta TV magnetici.

Metal wall system graphite finishing with
front doors in concrete finishing.
Integrated modular bookcase **IRON-IC**.
Magnetic shelves and TV holder.

D e s i g n

R O N D A D E S I G N L A B

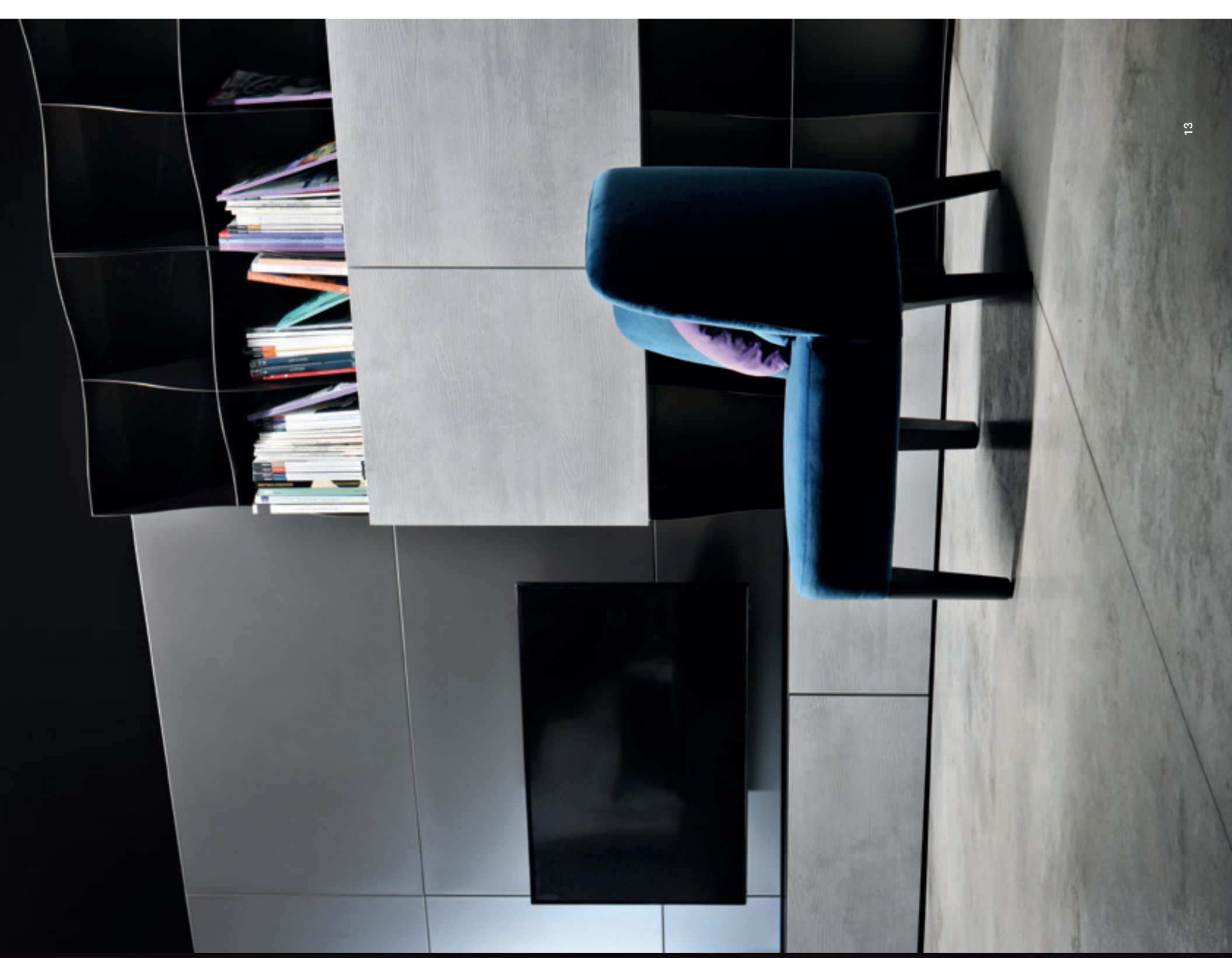



MENSOLE - SHELVES

M A G N E T I K A



L 300 P 220 H 300 mm

MENSOLE MAGNETICHE liberamente posizionabili sulle boiserie in metallo. Struttura in metallo finitura grafite e ripiani in finitura cemento.

MAGNETIC SHELVES which can be freely arranged on the metal panels. Metal structure in graphite finishing and shelves in concrete finishing.

D e s i g n

R O N D A D E S I G N L A B







LIBRERIA - BOOKCASE

I R O N - I C

Modulo _ Module L 720 P 300 H 720 mm

Libreria modulare in ferro naturale
dal profilo curvilineo.

Modular bookcase made of natural
iron with a curvilinear profile.

D e s i g n

R O N D A D E S I G N L A B







IRON-IC Design: Ronda Design Lab
Libreria modulare in metallo verniciato bianco opaco dal profilo curvilineo.
Modular bookcase in matt varnished metal, white finish. Curvilinear profile.



LIBRERIA - BOOKCASE

S U

L 400 P 400 H 2005 mm

Libreria free-standing in metallo,
finitura moka.

Free-standing metal bookcase
in moka finish.

Design

DIEGO COLLAREDA

ETIMODESIGN



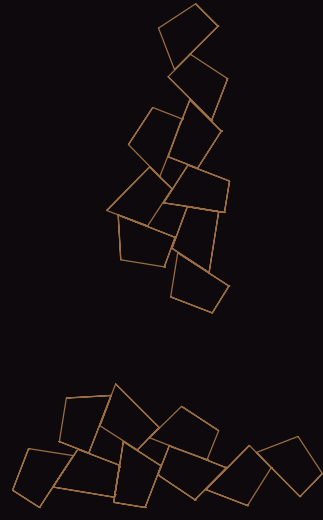

LIBRERIA - BOOKCASE

W - S U L I N E

L 720 P 250 H 1800 mm

Libreria a parete in metallo,
finitura moka e ferro naturale.
Posizionabile in orizzontale o in verticale.

Wall-mounted metal bookcase
in moka and natural iron.
Suitable for horizontal and vertical fitting.

Design

DIEGO COLLAREDA

ETIMODESIGN





LINK L20 Design: Aciriani e Rossi _ Ronda Design Lab
Composizione giorno in metallo con vano porta TV in vetro specchiato, Basi in acciaio satinato e boiserie in finitura ottone anticato.
Metal wall system with TV storage in mirrored glass, Brushed steel bases and aged brass panels.



PORTA TV - TV CABINET

M R H Y D E

L 1620 P 164 H 1440 mm

Sistema porta TV in vetro specchiato nero.
Anta apribile con cerniere laterali.
Adatto per schermi fino a 60".

TV mounting system with a black mirrored glass front.
Front door can be opened on lateral hinges.
Suitable for TV screens up to 60".

D e s i g n

A D R I A N I E R O S S I





SEGNO Design: Adriani e Rossi
Sistema di boiserie in metallo finitura ottone anticato con mensole integrate in alluminio finitura moka. Predisposizione per retroilluminazione led.
Aged Brass panel system with integrated aluminum shelves in moka finishing. Suitable for led backlighting.



SEGNO Design: Acriani e Fossi
Mensole in alluminio finitura moka dal profilo irregolare.
Irregularly shaped shelves in moka finished aluminum.



Basil in acciaio satinato. Angoli a 45 gradi su anta e scocca e scocca, angolari cromati.
Brushed steel drawers. Doors and body with 45 degrees edges, chromed angles.

S O H O



L 2200 P 535 H 865 mm

Madia free-standing con corpo e ante in acciaio satinato. Struttura di supporto in laccato opaco nero con vano per televisore a scomparsa. Retroilluminazione led opzionale.

Freestanding sideboard with brushed steel body and doors. Matt lacquered supporting structure in black finish with retractable TV storage. Optional led backlighting.

Design

RONDA DESIGN LAB









MENSOLE - SHELVING

ESAGONI

L 2275 P 200 H 1820 mm

Composizione di elementi magnetici esagonali liberamente posizionabili sulla parete metallica decorata con carta da parati.
Pannelli e mensole in finitura moka e grafite con ripiani in vetro.

Decorative shelving system consisting of magnetic hexagonal elements which can be freely arranged on the metal wall, finely decorated with wallpaper. Panels and shelves in moka and graphite finishing with glass ledges.

Design

RONDA DESIGN LAB



DECORAZIONI - DECORATIONS

MAGNETIC WALLPAPER

Sistema magnetico decorato
con carta da parati personalizzabile.
Mensole e accessori magnetici
liberamente posizionabili senza
necessità di forare la parete.

Magnetic system decorated with
customizable wallpaper.
Magnetic shelves and accessories can
be freely arranged without wall drilling.

Design

RONDA DESIGN LAB
ADRIANI E ROSSI





GIORNO - LIVING

LINK L10

L 3780 P 560 H 3240 mm

Composizione giorno in acciaio satinato e rovere foscille. Basi con scocca in acciaio e ante impiallacciate. Raffinati angoli a 45 gradi. Boiserie in metallo impiallacciato con mensole magnetiche in acciaio e porta TV magnetico. Mensola **AGO&FILO** con inserti in alluminio finitura moka.

Wall system in brushed steel and bog oak. Bases with steel structure and veneered doors. Refined 45 degrees edges. Veneered metal panels with steel magnetic shelves and magnetic TV bracket. **AGO&FILO** shelf with aluminum inserts in moka finishing.

Design

RONDA DESIGN LAB



MENSOLA - SHELF

A G O L O & F I L O

L 2700 P 260 H 450 mm

Mensole in alluminio verniciato moka liberamente posizionabili lungo il ripiano impiantato rovere fossile. Retroilluminazione led opzionale.

Varnished aluminum shelves in moka finishing, which can be freely positioned along the veneered bog oak ledge. Optional led backlighting.

D e s i g n

R O N D A D E S I G N L A B





LIBRERIA - BOOKCASE

I R O N - I C S H E L T E R

Modulo_ Modulo L 720 P 300 H 720 mm
Modulo contenitore_Cabinet module L 720 P 360 H 720 mm

Libreria modulare in metallo verniciato finitura moka.
Contentori incassati con scocca in laccato opaco
cacao e anta in rovere fossile.

Modular bookcase in moka varnished metal.
Built-in cabinets with cocoa matt lacquered body
and bog oak front doors.

Design
RONDA DESIGN LAB







BASI CONTENITORI - BASE DRAWERS

LINK Design: Ronda Design Lab



Struttura e frontal inox
Stainless steel body and front door



Struttura inox - frontal legno
Stainless steel body - veneered front door



Angolo 45°
45° corner

Dimensioni - Dimensions (mm)
Profondità - Depth 560 mm

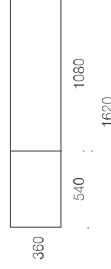

Soluzioni compositive - Solutions

Soluzione - Solution 01



Soluzione - Solution 02

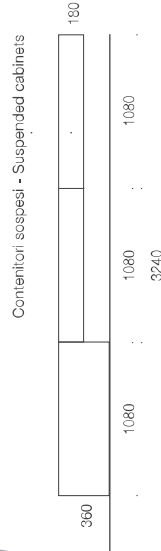

Soluzione - Solution 03

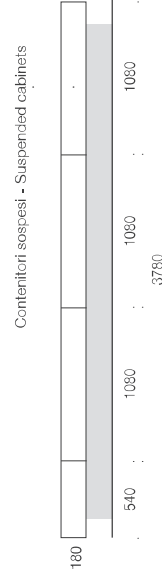

Soluzione - Solution 04

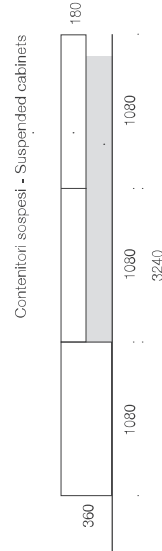

Finiture - Finishes

Struttura - Body



Acciaio satinato
Brushed steel

Frontali - Doors



Rovere fossile
Bog oak



Noce canaletto
American walnut



Base opzionale in acciaio inox
Optional stainless steel base

BASI CONTENITORI - BASE DRAWERS

IRON Design: Ronda Design Lab



Contentitori in legno con cover in metallo
Wooden cabinet with metal cover



Dimensioni - Dimensions (mm)
Profondità - Depth 560 mm



Soluzione compositiva - Solution

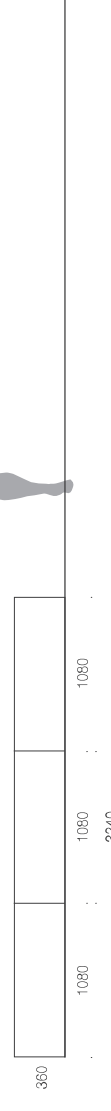

Finiture - Finishes

Cover metallica - Metal cover

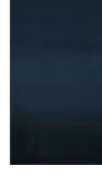

Ferro naturale
Natural iron

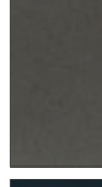

Grafite
Graphite



Bianco
White



Moka
Moka

Frontali - Doors



Cemento
Concrete



Rovere fossile
Bog oak



Noce canaletto
American walnut

LIBRERIA CONTENITORE - STORAGE SYSTEM

IRON-IC Design: Ronda Design Lab



Libreria modulare in metallo
Modular metal bookcase

Dimensioni - Dimensions (mm)

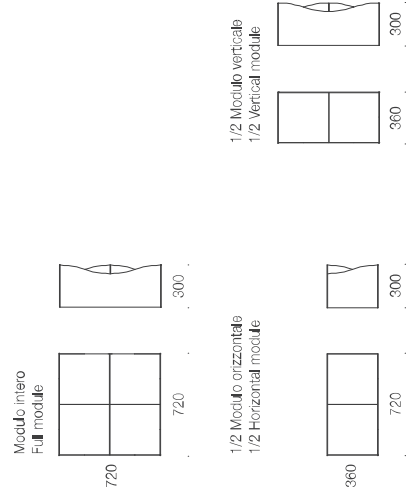

SHELTER Design: Ronda Design Lab



Iron-ic con contenitore incassato
Iron-ic with built-in cabinet

Dimensioni - Dimensions (mm)

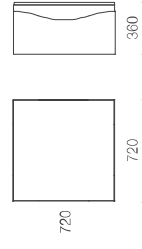

Soluzioni compositive - Solutions

Soluzione - Solution 01

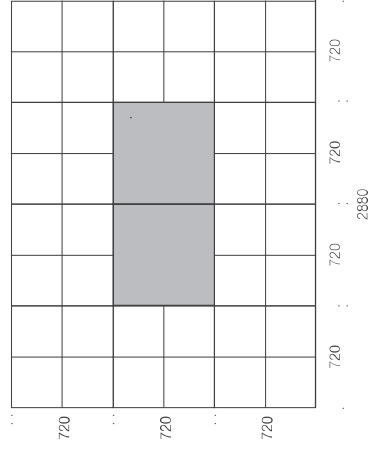

Finiture - Finishes

Libreria - Bookcase

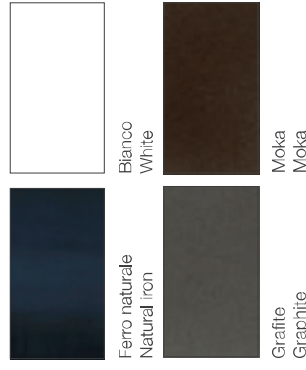

BOISERIE IN METALLO - METAL BOISERIE

BASIC Design: Ronda Design Lab



Boiserie in ferro verniciato spessore 28 mm.
Varnished metal panel thickness 28 mm.

Dimensioni - Dimensions (mm) Spessore - Thickness 28 mm

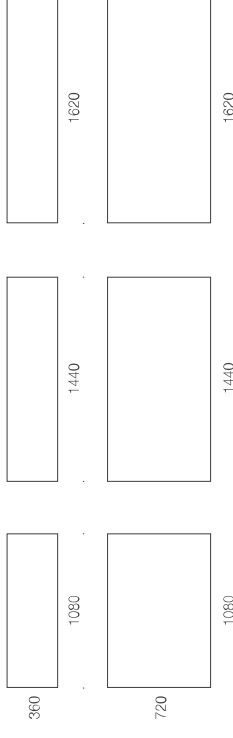

Soluzioni compositive - Solutions

Soluzione - Solution 01

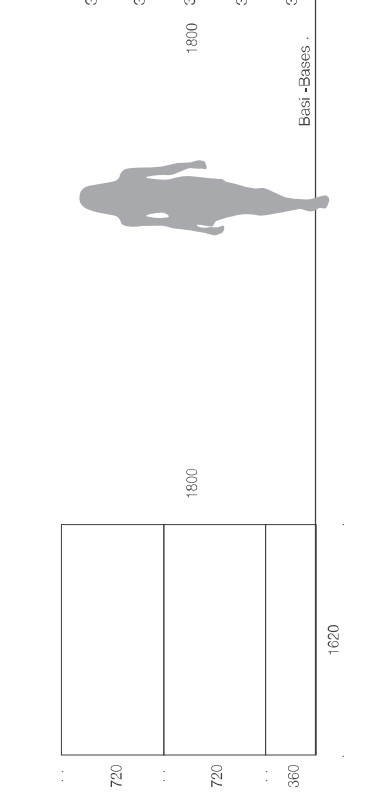

Finiture - Finishes

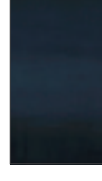

Ferro naturale
Natural iron

Bianco
White

Grafite
Graphite

Moka
Moka

Ottone anticato
Aged brass

Spessore 28 mm
Thickness 28 mm

magnetika

Tutte le boiserie sono adatte per l'utilizzo di mensole ed accessori magnetici
All the metal panels can be used with magnetic shelves and accessories



Retroluminazione led opzionale.
Optional led backlighting.



Soluzione - Solution 02

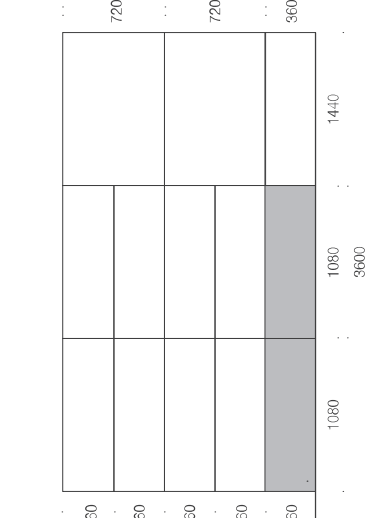

Ante - Front doors



Cemento
Concrete

Rovere fossile
Bog oak

Noce canaletto
American walnut

BOISERIE IN METALLO - METAL BOISERIE

WOOD Design: Ronda Design Lab



Spessore **20** mm
Thickness **20** mm

magnetika

Tutte le boiserie sono adatte per l'utilizzo di mensole ed accessori magnetici
All the metal panels can be used with magnetic shelves and accessories

Boiserie in metallo impiallacciato legno spessore 20 mm.
Metal panel with real wood veneering thickness 20 mm.

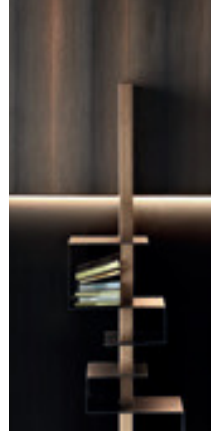

Distanza dalla parete 20 mm.
Distance from the wall 20 mm.

20 20

Dimensioni - Dimensions (mm)
Spessore - Thickness 20 mm

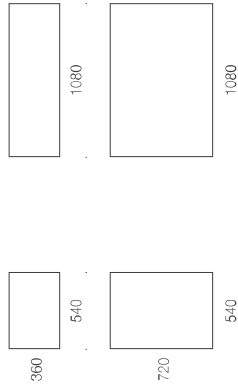

Soluzioni composite - Solutions

Soluzione - Solution **01**

Soluzione - Solution **02**

Soluzione - Solution **03**

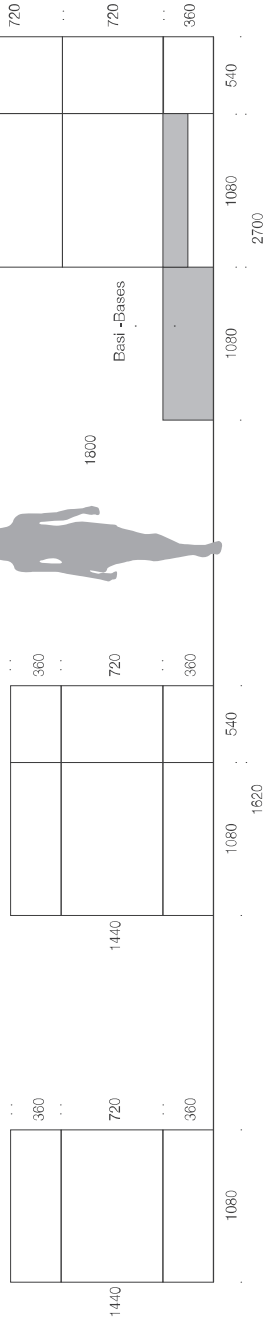

Finiture - Finishes



Rovere fossile
Bog oak



Noce canaletto
American walnut

BOISERIE IN METALLO - METAL BOISERIE

IRON Design: Ronda Design Lab



Spessore **28** mm
Thickness **28** mm

magnetika

Tutte le boiserie sono adatte per l'utilizzo di mensole ed accessori magnetici
All the metal panels can be used with magnetic shelves and accessories

Boiserie in ferro naturale con borchie
Natural iron panels with studs

Dimensioni - Dimensions (mm)
Spessore - Thickness 28 mm

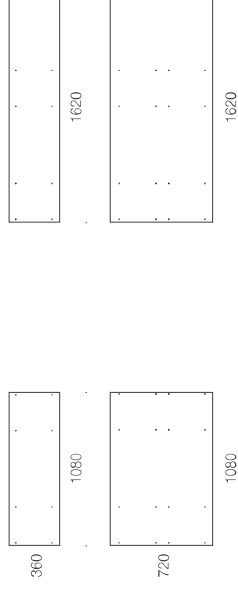

Soluzioni composite - Soluzioni composite

Soluzione - Solution **01**

Soluzione - Solution **02**

Soluzione - Solution **03**

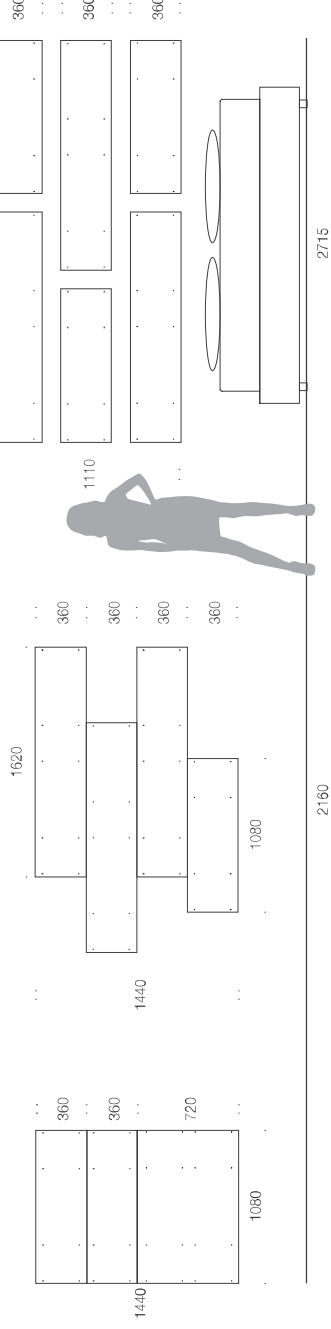

Finiture - Finishes

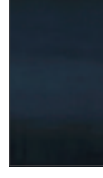

Ferro naturale
Natural iron

RIVESTIMENTI METALLICI - METAL WALL PANNELLING

Spessore **1,5 mm**
Thickness **1,5 mm**

FLAT

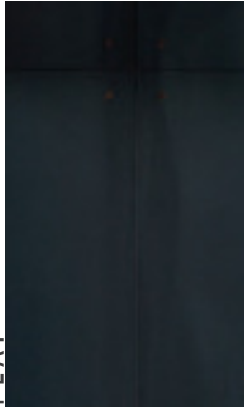

magnetika

Tutte le boiserie sono adatte per l'utilizzo di mensole ed accessori magnetici
All the metal panels can be used with magnetic shelves and accessories

Fogli di metallo verniciato.
Varnished metal sheets.

Taglio su misura - Custom size
Spessore - Thickness **1,5 mm**



Dimensioni standard- Standard dimensions (mm)
Spessore - Thickness **1,5 mm**

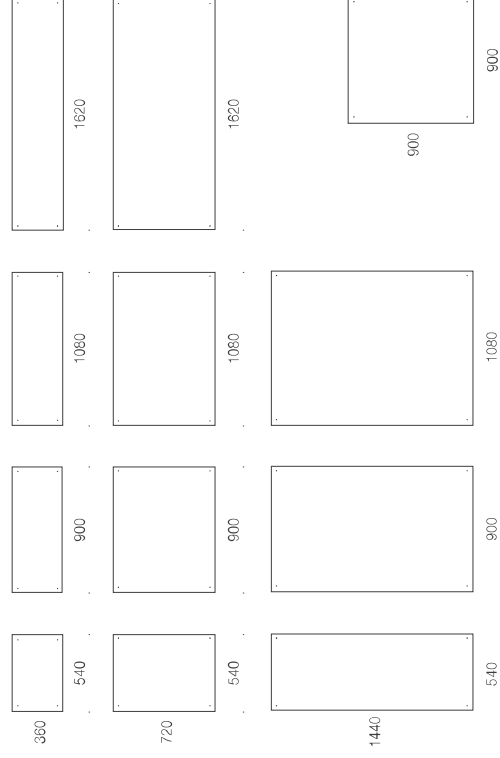

Soluzioni composite - Solutions

Soluzione - Solution **01**

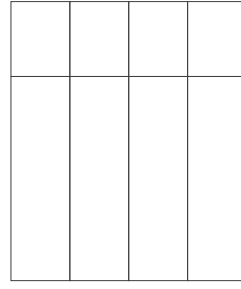

Soluzione - Solution **02**

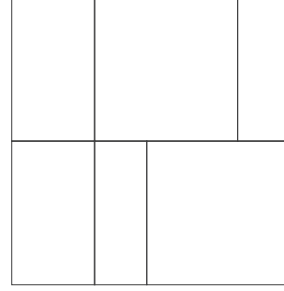

Soluzione - Solution **03**

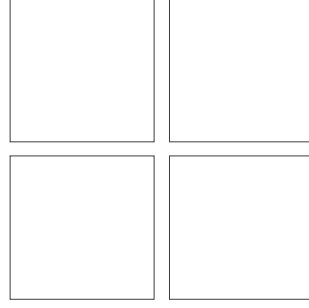

Finiture - Finishes



Ferro naturale
Natural iron

Grafite
Graphite

Moka
Moka

Bianco
White

CARTA DA PARATI MAGNETICA - MAGNETIC WALLPAPER



magnetika

Utilizzabile con tutte le mensole e accessori magnetici
Can be combined with any magnetic shelf and accessories

Carta da parati con grafiche personalizzabili integrata ad un sistema magnetico di mensole e accessori liberamente posizionabili senza necessità di forare la parete.
Customizable wallpaper integrated with a magnetic system of shelves and accessories which can be freely arranged without wall drilling.



SPECCHIO TV - MIRROR TV

MR HYDE Design: Adriani e Rossi

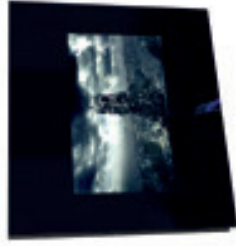

Retroilluminazione led opzionale.
Optional led backlighting.

Contenitore porta TV in vetro specchiato nero. All'accensione del televisore lo specchio si trasforma e lascia intravedere lo schermo.
Anta apribile con cerniere laterali. Televisore non in dotazione.
Wall mounted TV storing cabinet with a black mirror door. Once turned on, the television becomes visible through the glass door.
Front door with lateral hinges. Does not include television.

Dimensioni - Dimensions (mm)
Profondità esterna - External depth 164 mm **Profondità interna - Internal depth 140 mm**

Specchio porta TV con anta - Mirror with front door

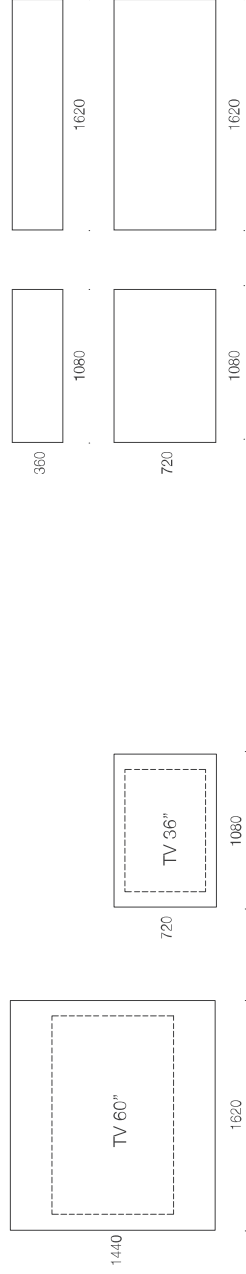

Soluzioni compositive - Solutions

Soluzione - Solution 01

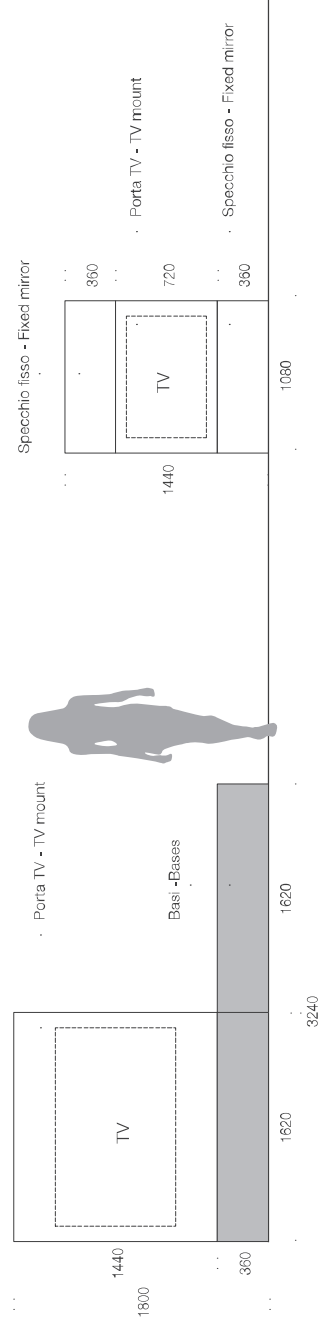

TV spenta - TV switched off

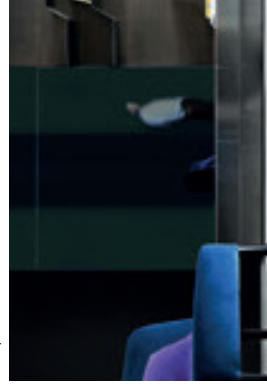

TV accesa - TV switched on

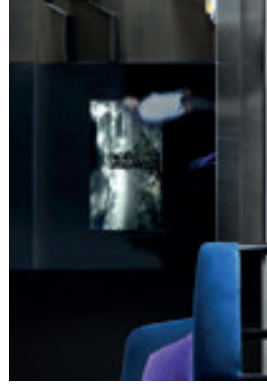

BOISERIE CON MENSOLA - PANELS WITH SHELF

SEGNO Design: Adriani e Rossi



Retroilluminazione led opzionale.
Optional led backlighting.

Boiserie in metallo con mensola integrata, pannello spessore 28 mm.
Metal panel with integrated shelf, panel thickness 28 mm.

Dimensioni - Dimensions (mm)
Spessore pannello 28 mm - Panel thickness 28 mm
Profondità mensola 250 mm (escluso pannello) - Shelf depth 250 mm (excluding panel)

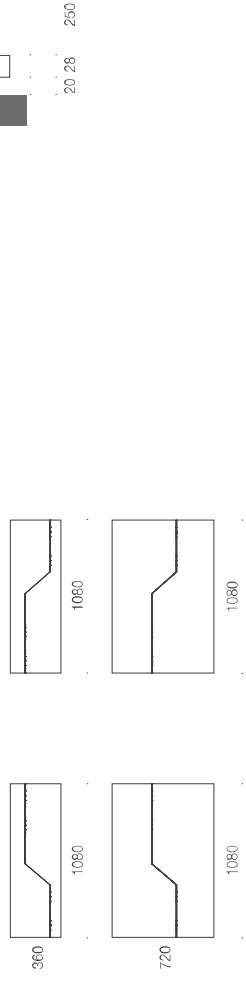

Soluzioni compositive - Solutions

Soluzione - Solution 01

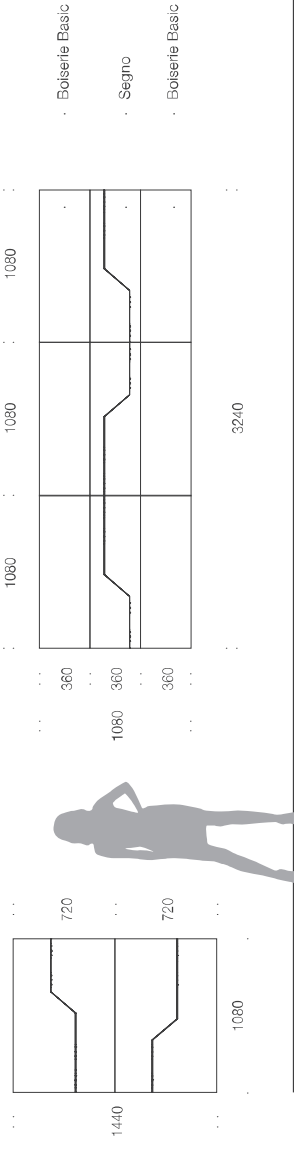

Soluzione - Solution 02

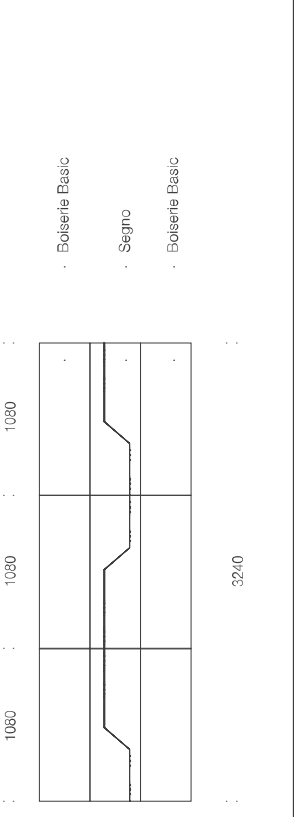

SEGNO Combinazioni finiture - Finishes combinations

Boiserie - Panel

Ottone antichato
Aged brass

Moka
Moka



Mensola - Shelf

Moka
Moka

Grafite
Graphite



PANNELLO ESAGONO

Design: Ronda Design Lab



Pannello esagonale fissabile alla parete magneticamente.
Hexagonal shape which can be wall mounted magnetically.

Dimensioni - Dimensions (mm)
Spessore pannello 20 mm - Panel thickness 20 mm

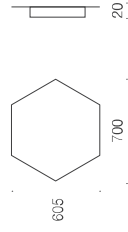

Dimensioni - Dimensions (mm)
Profondità mensola 200 mm - Shelf depth 200 mm

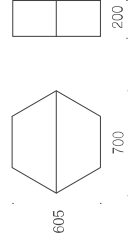

Mensola magnetica esagonale con ripiano in vetro.
Magnetic shelf Hexagonal shaped with glass ledge.

Soluzioni compositive - Solutions

Soluzione - Solution 01

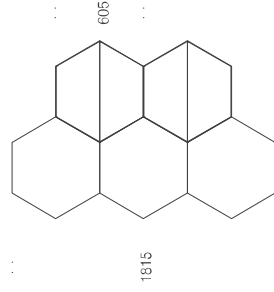

Soluzione - Solution 02

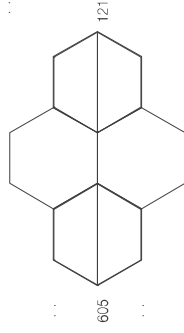

Soluzione - Solution 02

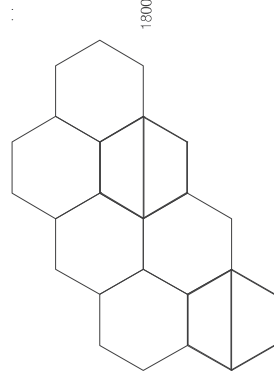

Finiture - Finishes



IRON

Design: Ronda Design Lab

Struttura - Structure

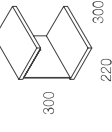

Mensola magnetica
Magnetic shelf

Ripiani - Shelves



Cemento Concrete

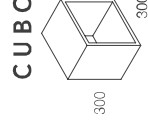
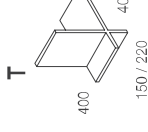
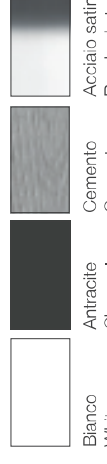
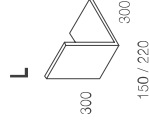

RETTANGOLO

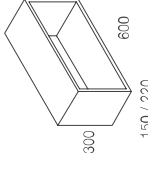

Y

Design: Marco Fumagalli

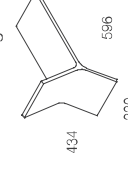

TRAPEZIO

Design: Marco Fumagalli

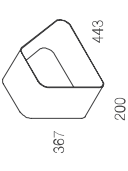

TRIANGOLO

Design: Marco Fumagalli

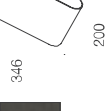
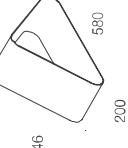

PORTA TV UNIVERSALE - UNIVERSAL TV MOUNT

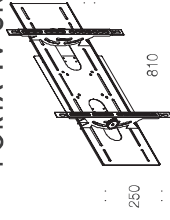

Portata massima 20 kg
Raccomandata per schermi da 37" a 60"
Attacco universale

Maximum load capacity 20 kg
Recommended for TV screens from 37" to 60"
Universal fixing system

PORTA TV VESA - VESA TV MOUNT



Portata massima 20 kg
Raccomandata per schermi con attacco Vesa

Maximum load capacity 20 kg
Recommended for TV screens with Vesa standard

LIBRERIE - BOOKCASES

SU Design: Diego Collareda, Etimodesign

Libreria verticale in metallo verniciato
Vertical bookcase made of varnished metal

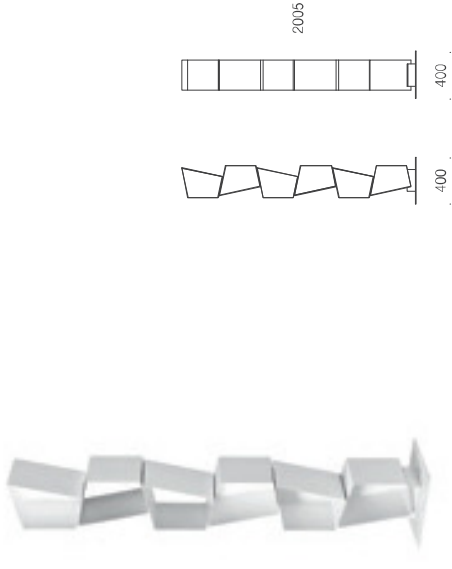
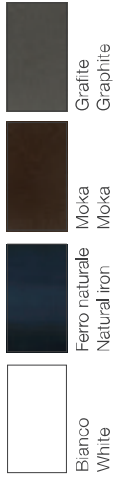

Retroilluminazione led opzionale.
Optional led backlighting.

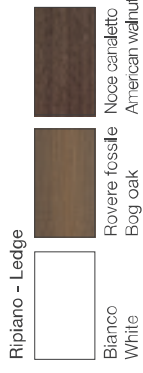

Mensola - Shelves

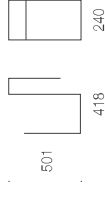

Mensole in alluminio verniciato liberamente posizionabili lungo il ripiano in legno.
Varnished aluminum shelves, which can be freely positioned along the wooden ledge.

AGO & FILO Design: Ronda Design Lab

SU LINE Design: Diego Collareda, Etimodesign

Libreria orizzontale in metallo verniciato con o senza pedana in legno.
Horizontal bookcase made of varnished metal Available with or without wooden platform

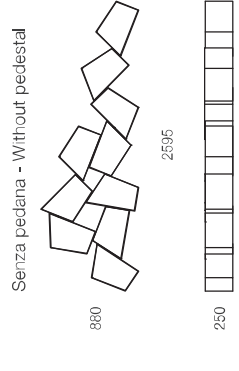
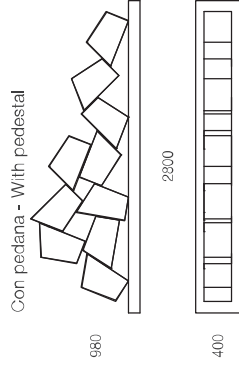
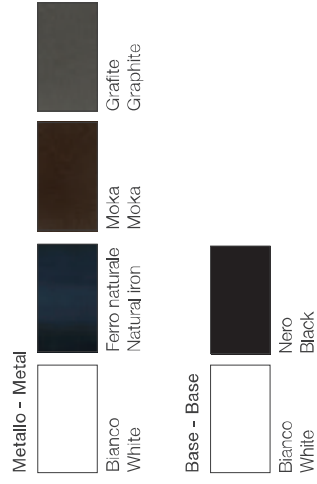

W SU LINE Design: Diego Collareda, Etimodesign

Libreria a parete in metallo verniciato.
W Su Line può essere montata sia in orizzontale che in verticale.
Wall mounted bookcase made of varnished metal.
W Su Line can be mounted both horizontally and vertically.

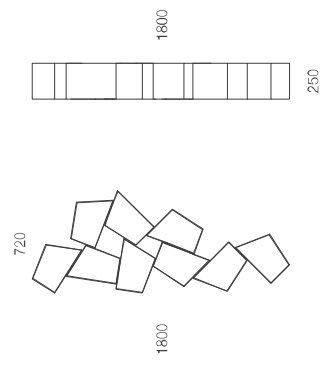
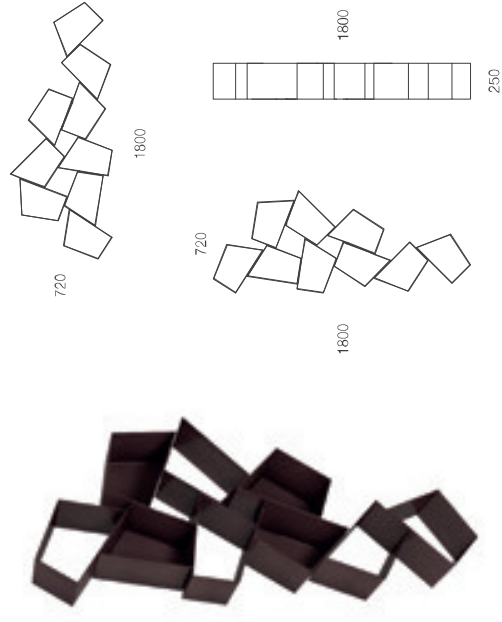
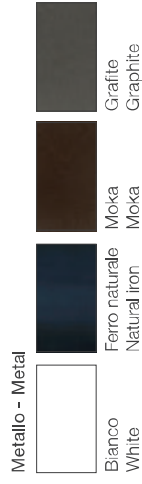

COMPLEMENTI - FURNISHINGS

AGO & FILO Design: Ronda Design Lab

Mensole in alluminio verniciato liberamente posizionabili lungo il ripiano in legno.
Varnished aluminum shelves, which can be freely positioned along the wooden ledge.



Retroilluminazione led opzionale.
Optional led backlighting.

Ripiano - Ledge



Mensola - Shelves

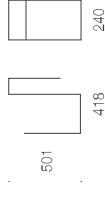

Ripiano magnetico - Magnetic shelves

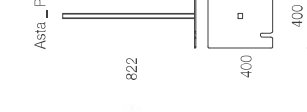
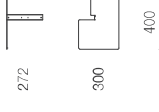

Libreria verticale in metallo verniciato composta da un'asta di sostegno ed una serie di ripiani che si fissano all'asta magneticamente.
Vertical bookcase made of varnished metal.
Hastag consists of a central pole and a set of magnetic shelves which can be freely positioned along the pole.

magnetika

Metallo - Metal

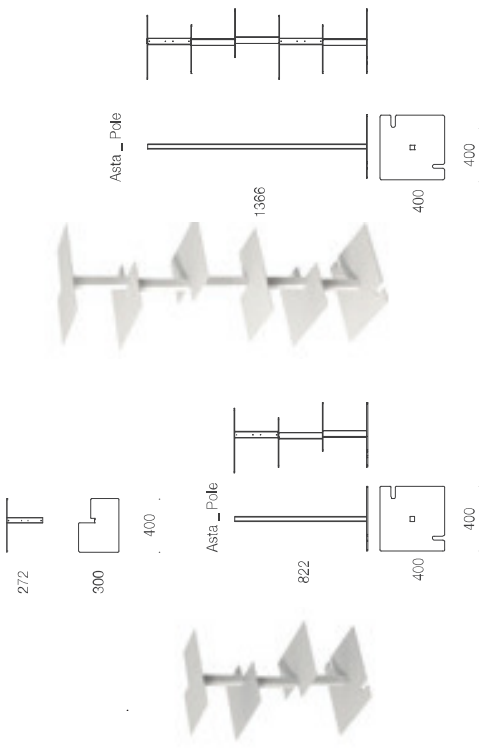
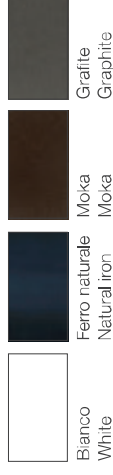

SOHO Design: Ronda Design Lab

Madia free-standing con corpo e ante in acciaio satinato.
Struttura di supporto in laccato opaco.
Disponibile con o senza vano per TV a scomparsa.
Freestanding sideboard with brushed steel body and doors.
Matt lacquered supporting structure.
Available with or without retractable TV storage.



Retroilluminazione led opzionale.
Optional led backlighting.

Madia - Cupboard

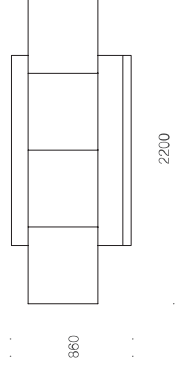

Con vano TV a scomparsa
With retractable TV storage

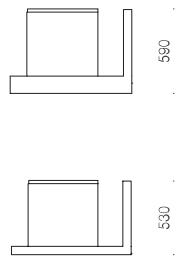

TAVOLI - TABLES

QUASIMODO Design: Adriani e Rossi

Tavolo con base in metallo e piano in cemento spatolato, sp. 14 mm, disponibile nel formato rettangolare oppure sagomato irregolare.
Table with metal base and brushed concrete top thickness 14 mm.
Rectangular or irregular shaped top.

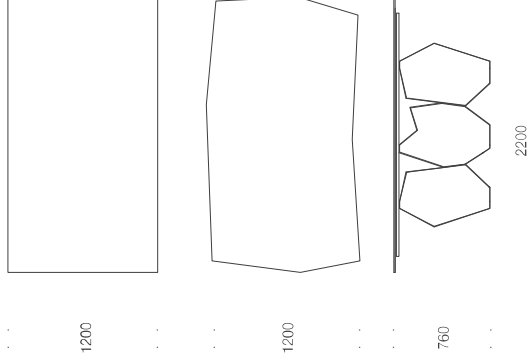

Base - Base

Grafite
Graphite

Top

Cemento spatolato
Brushed concrete

QUASIMODO Design: Adriani e Rossi

Tavolo con base in metallo e piano in vetro nero, sp. 12 mm, disponibile nel formato rettangolare oppure sagomato irregolare.
Table with a metal base and black glass top, thickness 12 mm.
Rectangular or irregular shaped top.

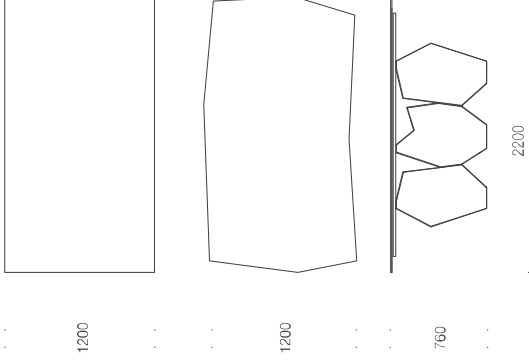

Base - Base

Grafite
Graphite

Top

Vetro nero
Black glass

URBAN Design: Ronda Design Lab

Tavolo con gambe a cavalletto in ferro naturale, piano rettangolare.
Table with industrial iron trestles, rectangular top.

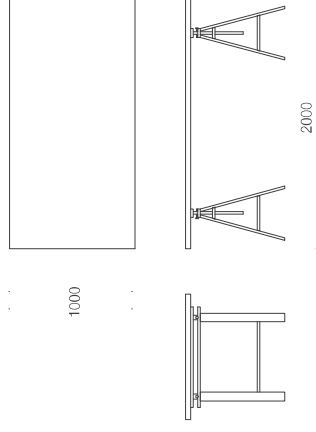

Base - Base

Ferro naturale
Natural iron

Top

Cemento spatolato
Brushed concrete

Vetro fumè
Smoked glass

Rovere naturale
Natural oak

Noce canaletto
American walnut

COMPLEMENTI - FURNISHINGS

IZOARD Design: Adriani e Rossi

Sedia con struttura in metallo e seduta imbottita.
Chair with metal structure and upholstered seat.

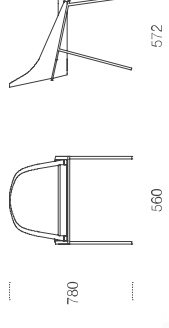

Struttura - Body

Grafite
Graphite

Seduta - Seat

Finiture da campionario
Finishes from color samples

WIRE Design: Luca Roccadadria

Tavolino da salotto in filo di ferro verniciato, piano di appoggio in metallo.
Coffee table made of varnished metal wires, metal top.

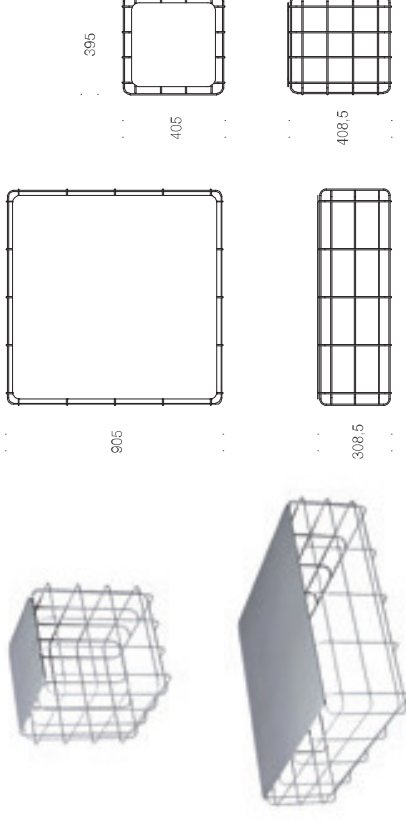

Struttura e piano - Body and top

Bianco
White

Moka
Moka

Grafite
Graphite

ADAMO Design: Ronda Design Lab

Specchio rettangolare con cornice di 160 mm in acciaio satinato.
Rectangular mirror with a 160 mm wide brushed steel frame.

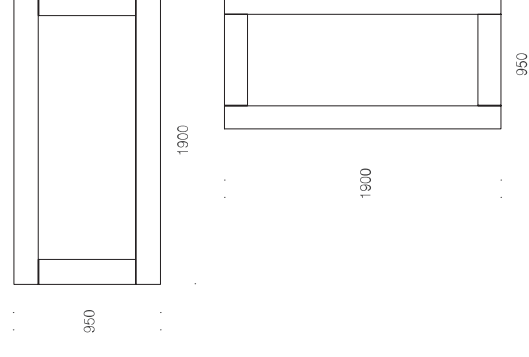

Acciaio satinato
Brushed steel

Ronda Design si riserva la facoltà di modificare in qualunque momento e senza preavviso, le caratteristiche tecniche degli elementi usati nel presente catalogo. Alcuni accessori presenti nelle immagini fotografiche non sono prodotti da **Ronda Design**.

Si prega di far riferimento al listino prezzi.

Ronda Design si riserva inoltre il diritto di apportare ai propri prodotti quelle modifiche che riterrà necessarie o utili al fine di migliorarli senza pregiudicarne le caratteristiche essenziali. È vietata ogni riproduzione totale e parziale in Italia e all'estero.

Ronda Design is entitled to modify the technical features of the elements used in this catalogue at any time and without giving notice. Some of the accessories shown in the photographs are not produced by **Ronda Design**. Please refer to the price list.

Ronda Design is entitled to make any modifications to its products that it deems necessary or useful to improve them without changing their essential features. Any total or partial reproduction in Italy or abroad is prohibited.

Ringraziamo per la collaborazione **Mazzoli S.r.l.**

A special thanks to **Mazzoli S.r.l.**

A.D. / Graphic: Adriani e Rossi Edizioni

Stylist: Silvana Bicego

Photo: Studio Emozioni (Tv)

Printed in Italy February 2017 - Grafiche Antiga (Tv)



App Design S.r.l.

Via Volta, 29 - 36010 Zanè (VI) - Italy

Tel. +39 0445 1850142

Fax +39 0445 1850143

www.rondadesign.it
sales@rondadesign.it